

#acélszerkezetek

#tervezés

#gyártás

#kivitelezés

Alukonstrukt kapacitás

5 000

tonna acél / év

12 000

m² homlokzat / év

24 000

m² függönyfal / év

13 000 m² saját gyártó csarnok

180 alkalmazott

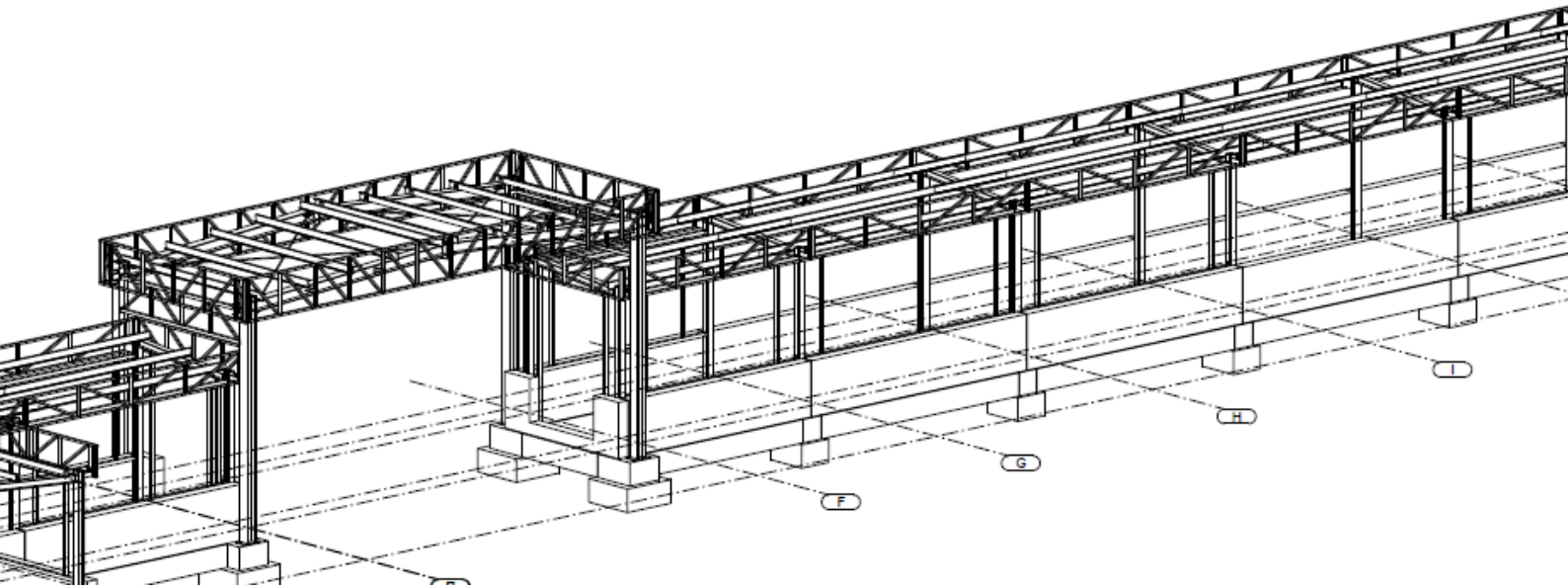

Acélgyártás

Erősségek

- # nagy átbocsátóképesség
- # összetett szerkezetek
- # egyedi megoldások
- # strukturált gyártás
- # 11híd daru
- # modern CNC állomás

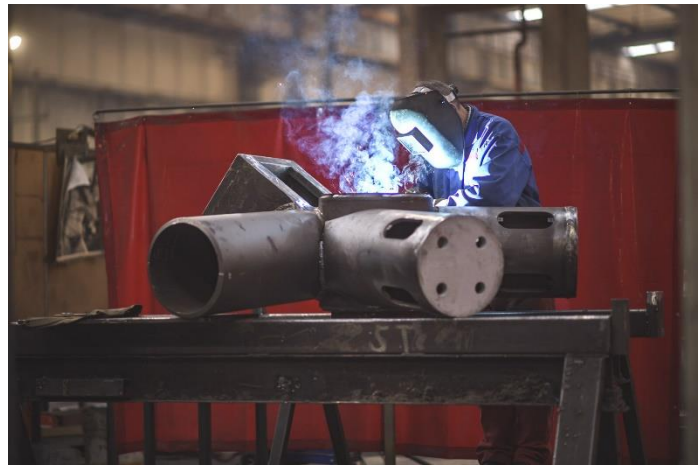

Gyártói tanúsítás

- # EN1090-1
- # EN 1090-2
- # EN 1090-4

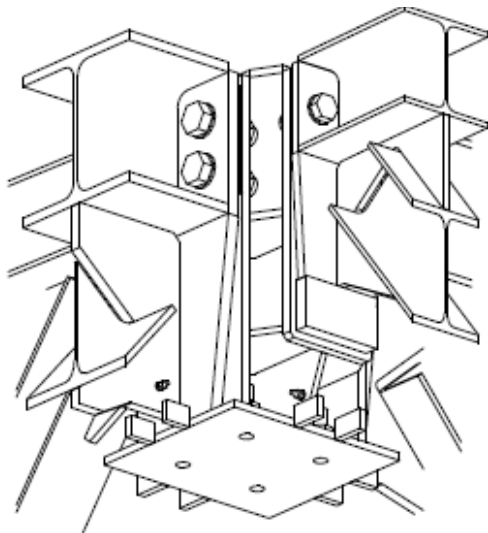

Beruházói együttműködések



#mezőgazdasági_épületek

#ipari_létesítmények

#egyedi_szerkezetek

#közösségi_épületek

#sport_létesítmények

#üvegtetők

#speciális_szerkezetek

Fontosabb referenciák



Audi, Győr



5 500
tonna acél

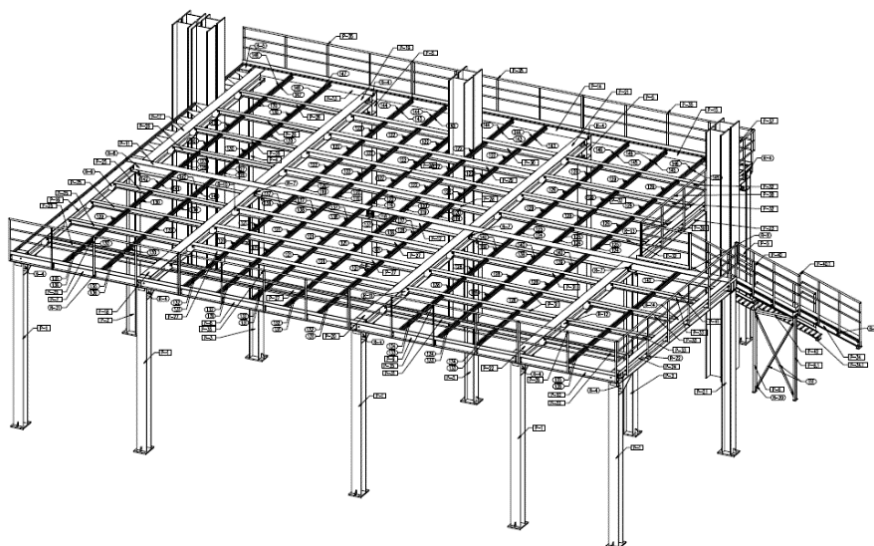

VARIABILNÝ DETAIL / VARIABLE DETAIL
VD D - BOTTOM
M 175

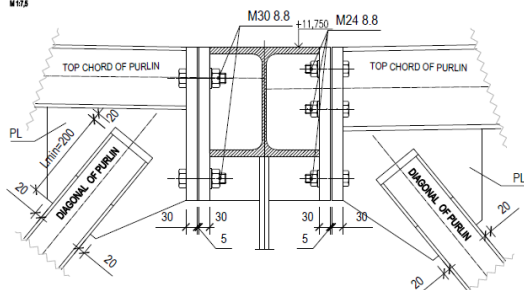

Fontosabb referenciák



Jaguár, Nitra (Szlovákia)



5 800
tonna acél



Fontosabb referenciák

Pannon Park, Biodóm -
Budapest

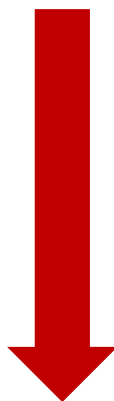

1000
tonna acél

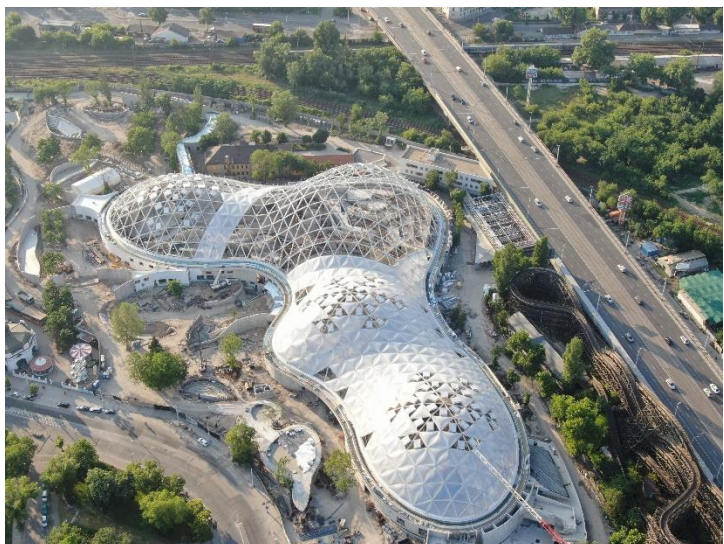
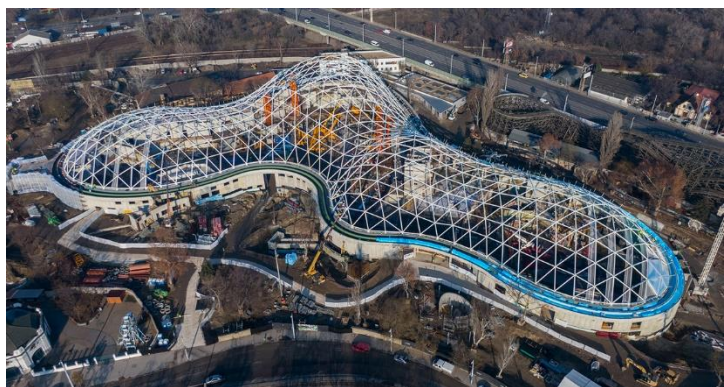
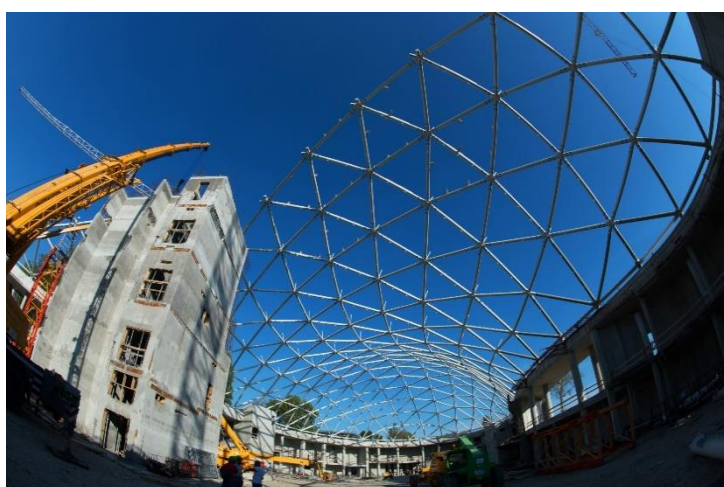
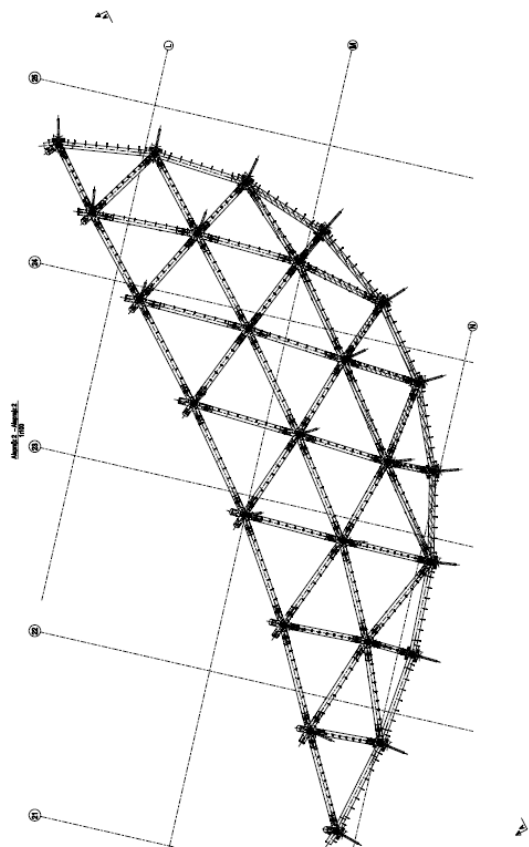



Egyedi megoldásokkal, egy
szebb jövőért.

alukonstrukt@alukonstrukt.hu

+36-62-554424

